

1

11304

LARS LAJ®



STAND ALONE

Product name: Merry-Go-Round
Catalogue number: 11304
Dimensions: 164x164 cm
Total height: 74 cm
Safety zone: 564x564 cm
Critical Falling Height: 74 cm
Requires falling surface: YES
Spare parts available: YES
Acc. to EN 1176: YES
Age level: 3+ years

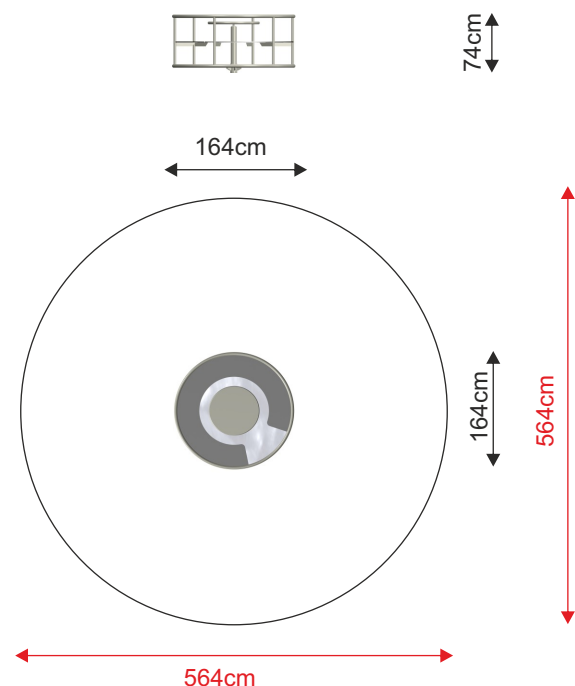
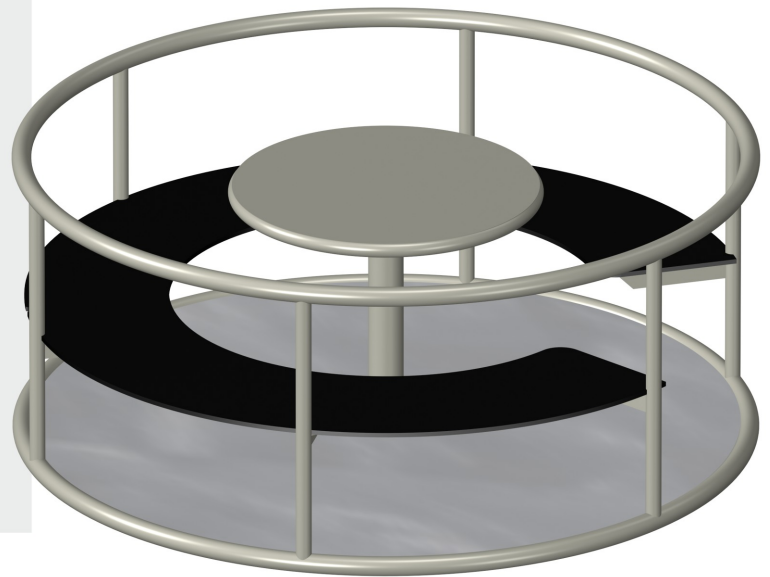

NOTICE:

The device has the ability to lubricate the bearings which should be done once a year to avoid potential damage.

PRODUCT DATA

Product name: Merry-Go-Round
Catalogue No.: 11304
Product type: Stand Alone

Critical Falling Height: 74 cm
Dimensions: 164x164 cm
Safety Zone: 564x564 cm
Age Level: 3+ years

COMPANY DATA

Name: _____
Address: _____
Zip code/city: _____
Place: _____
Phone: _____
Fax: _____
Email: _____

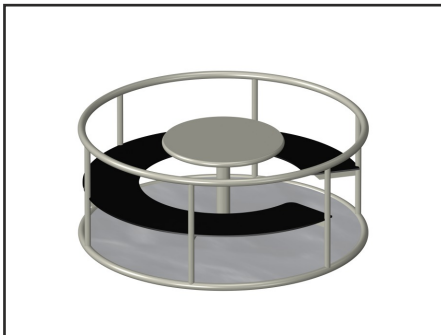
Product Photo/Picture**OWNERS DATA**

Name: _____
Contact: _____
Address: _____
Zip code/city: _____
Place: _____
Phone: _____
Fax: _____
Email: _____

AREA DATA

Placing: _____
Address: _____
Zip code/city: _____
Place: _____
Playground name: _____
Product number: _____

ADMINISTRATOR DATA

Name: _____
Contact: _____
Address: _____
Zip code/city: _____
Phone: _____
Fax: _____
Email: _____

SURFACE

Material: _____
Dimensions: _____
Underground: _____
Supplier: _____

Buying date: _____
Installation: _____
Guarantee: _____

3

11304

Product main dimensions

LARS LAJ[®]



STAND ALONE

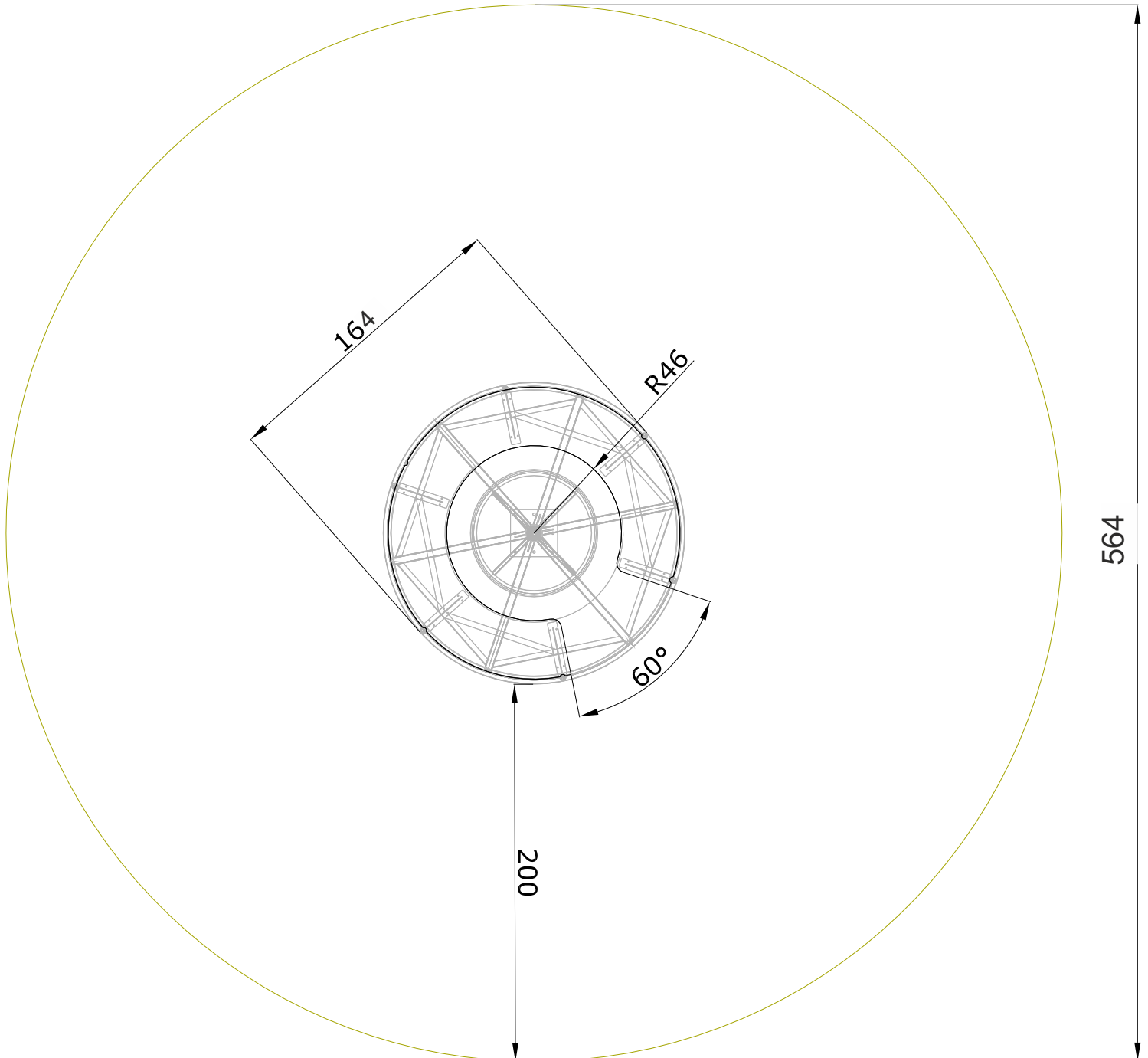
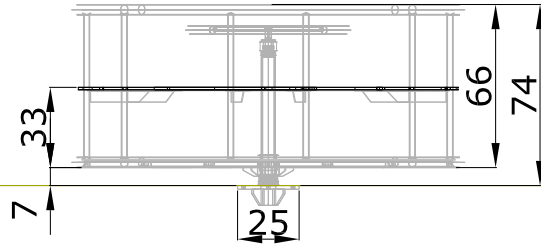

STAND ALONE

Implementation of the foundation:

1. Dig a hole and insert the rod basket.
Basket insert together with the upper and lower plywood.
2. After checking the setting - hole with basket fill with concrete.
3. After the concrete has set, remove the upper plywood, by unscrew nuts and washers. Keep the washer.

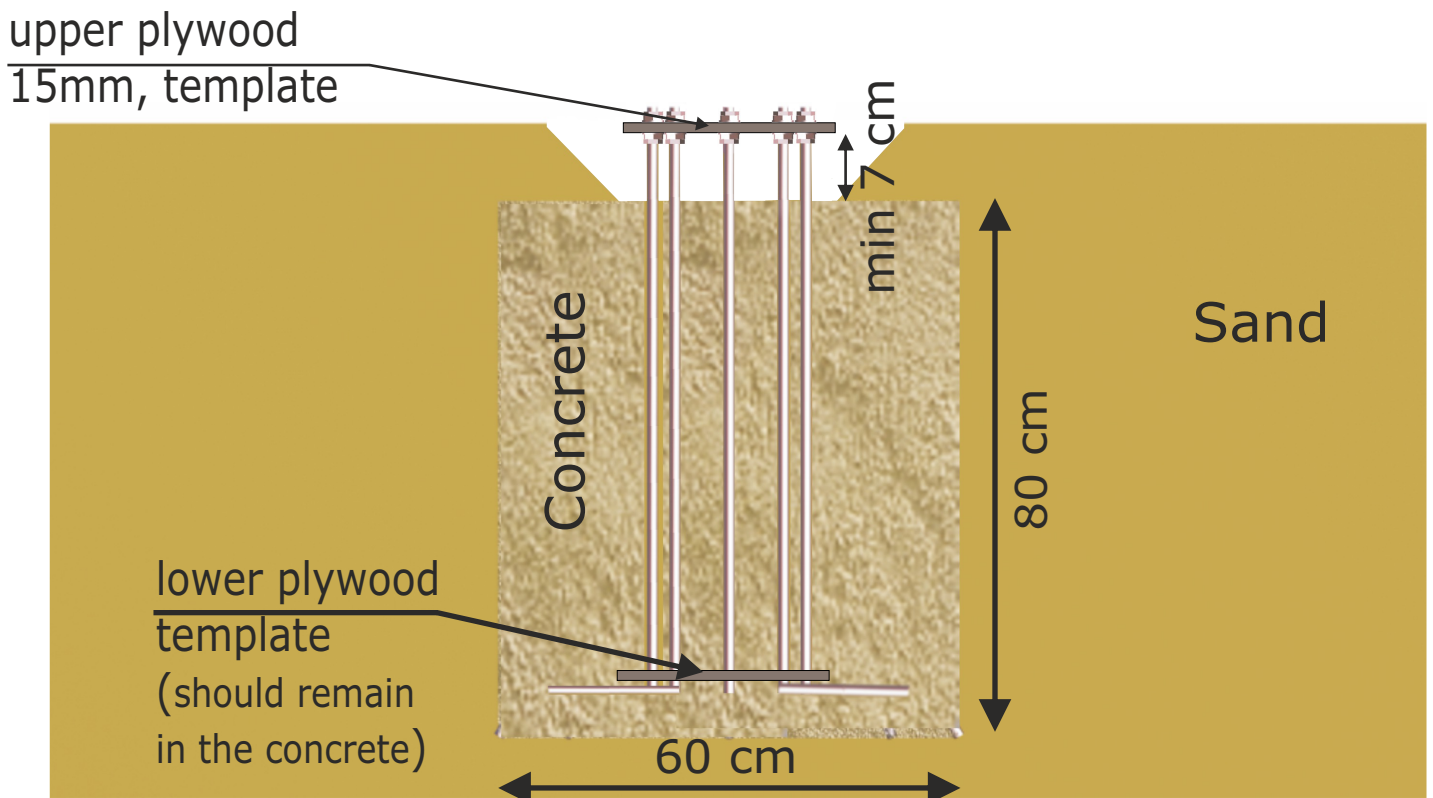

STAND ALONE

Fixing the carousel to the foundation:

1. Check the level of nuts.
2. Install the carousel using washers and self-locking nuts.

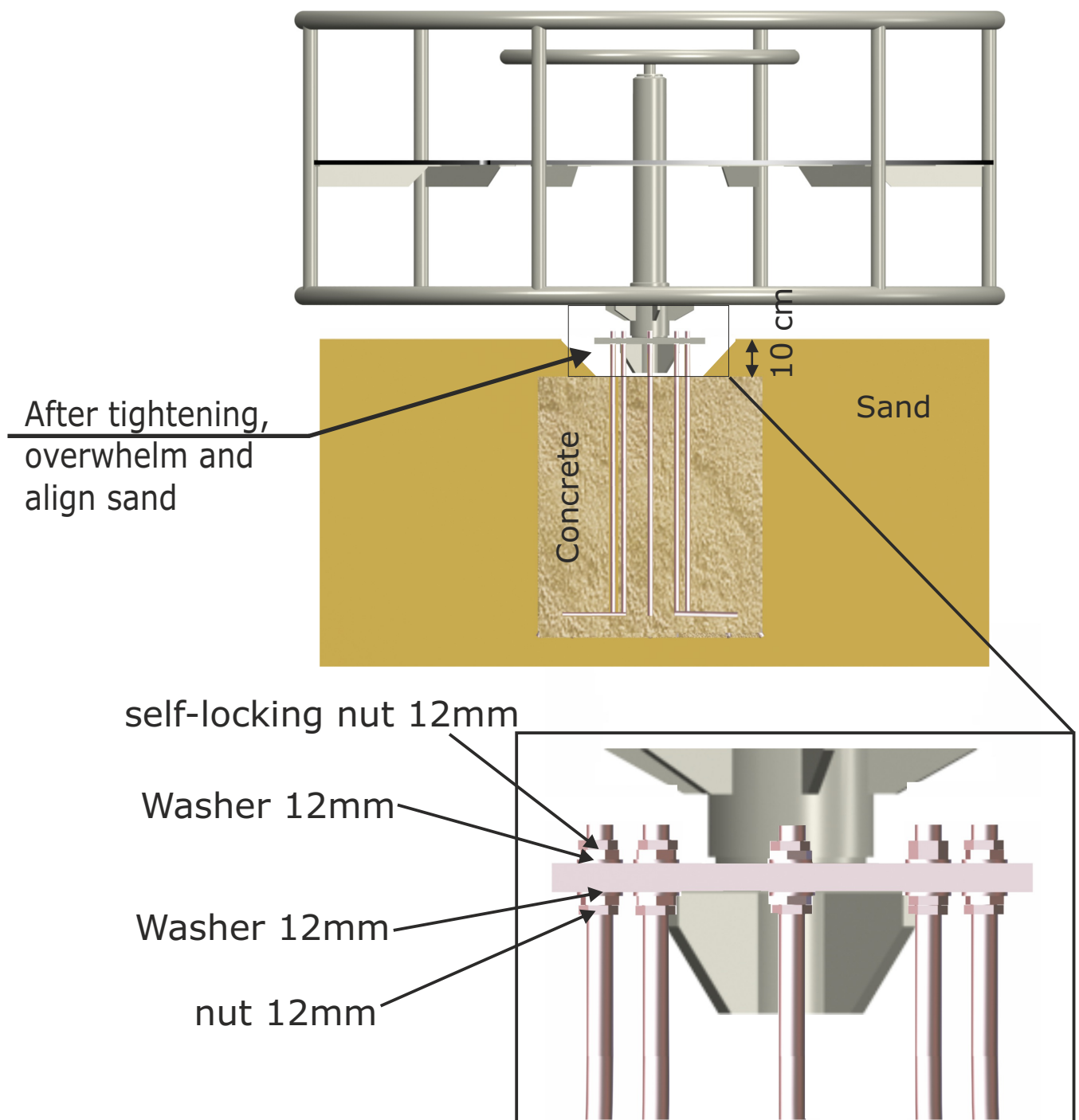

STAND ALONE

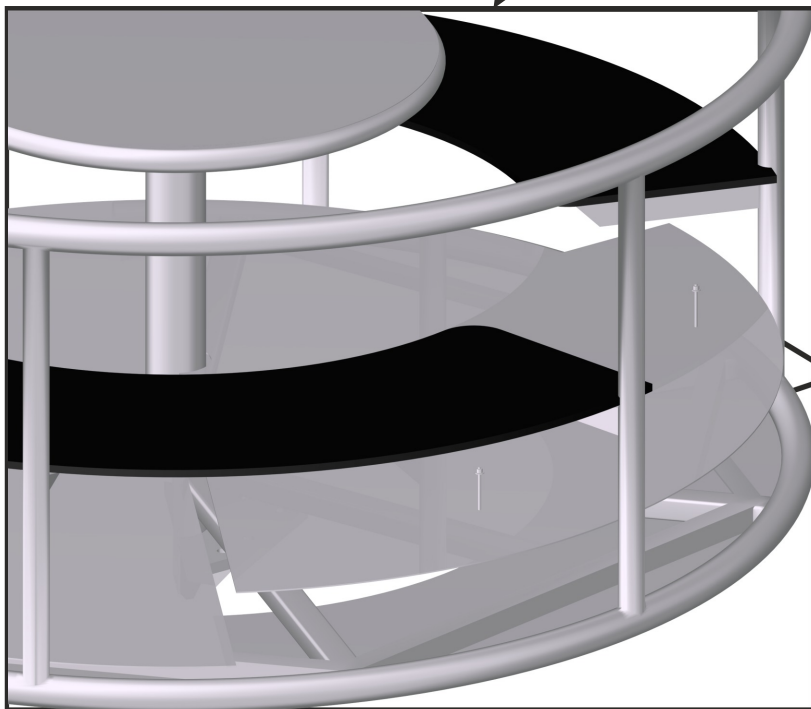
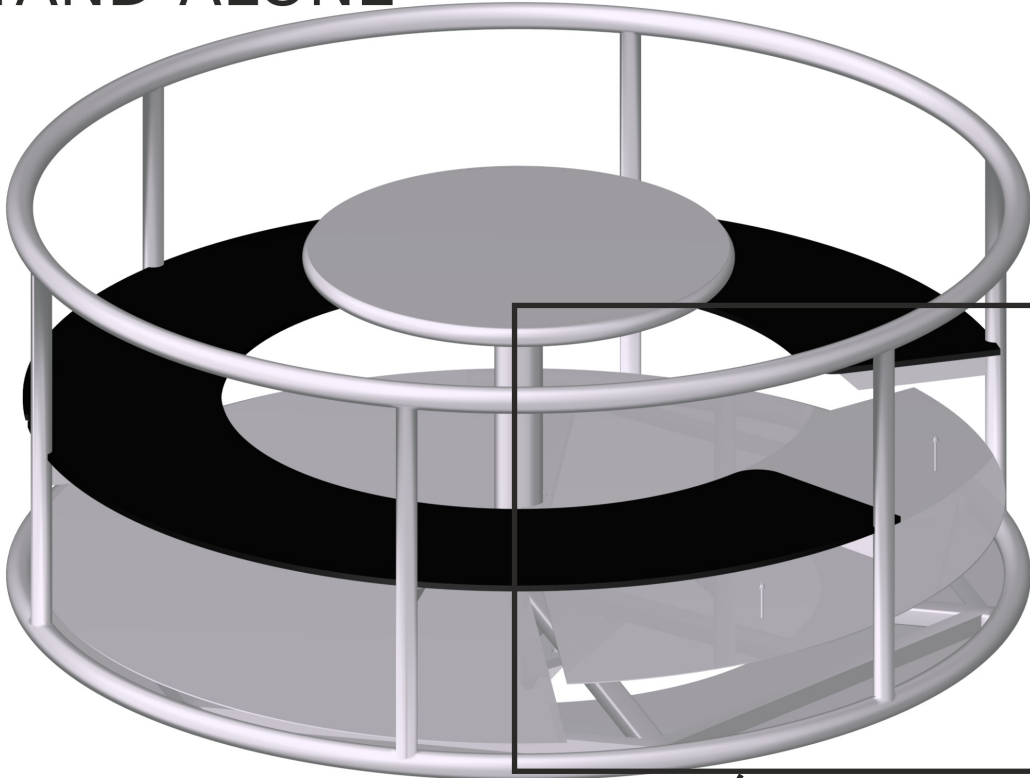

After installing Merry-Go-Round rivet the floor

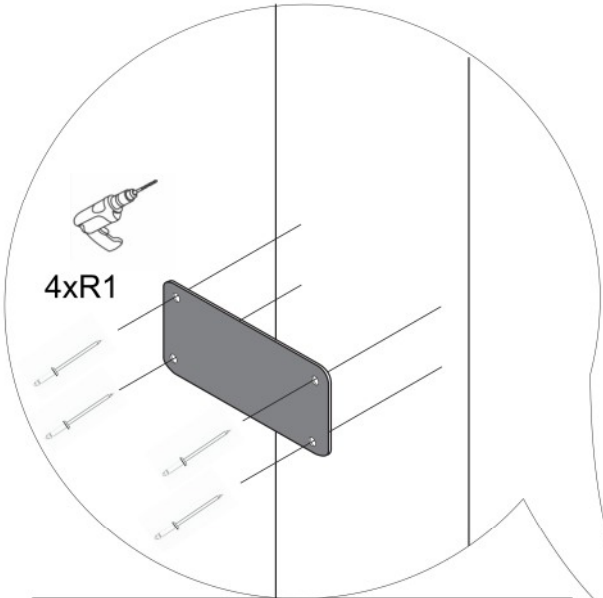

4xR1

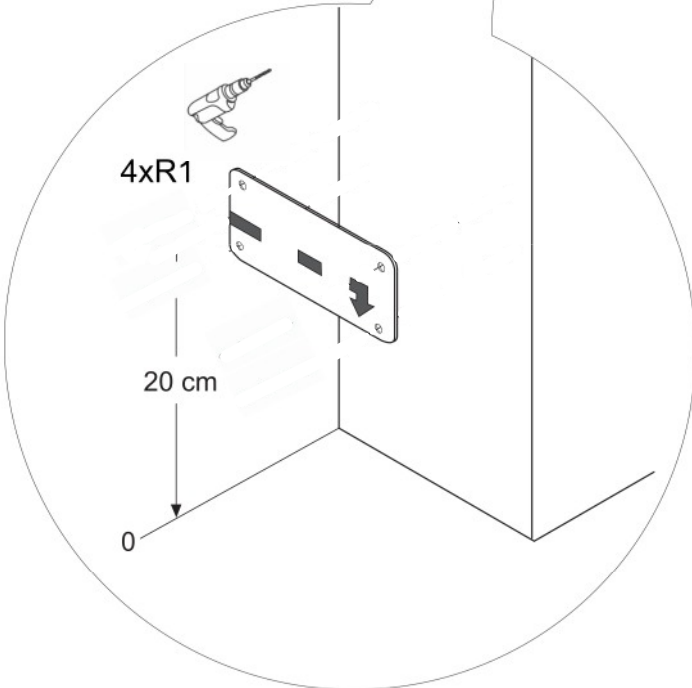
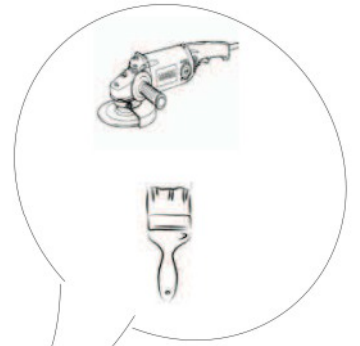
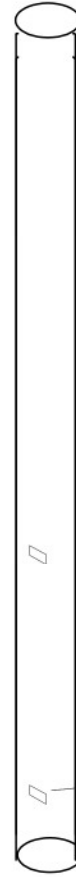
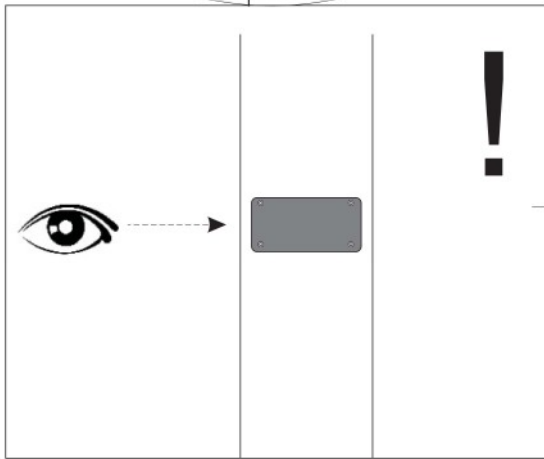

4xR1

20 cm

0

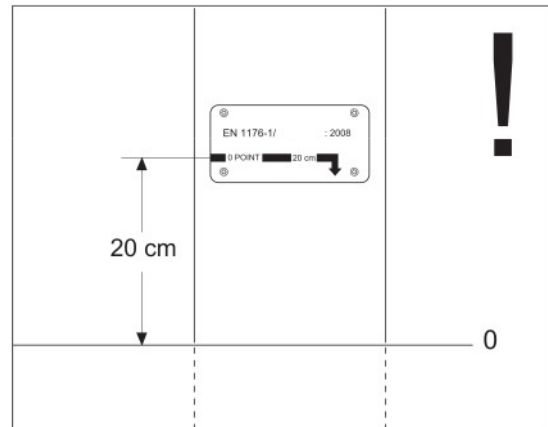

LARS LAJ[®]

Article	Ground level plate, Product Plate		
Made by	Caroline W.		
Date	28.08.2013	Modified	16.12.2014

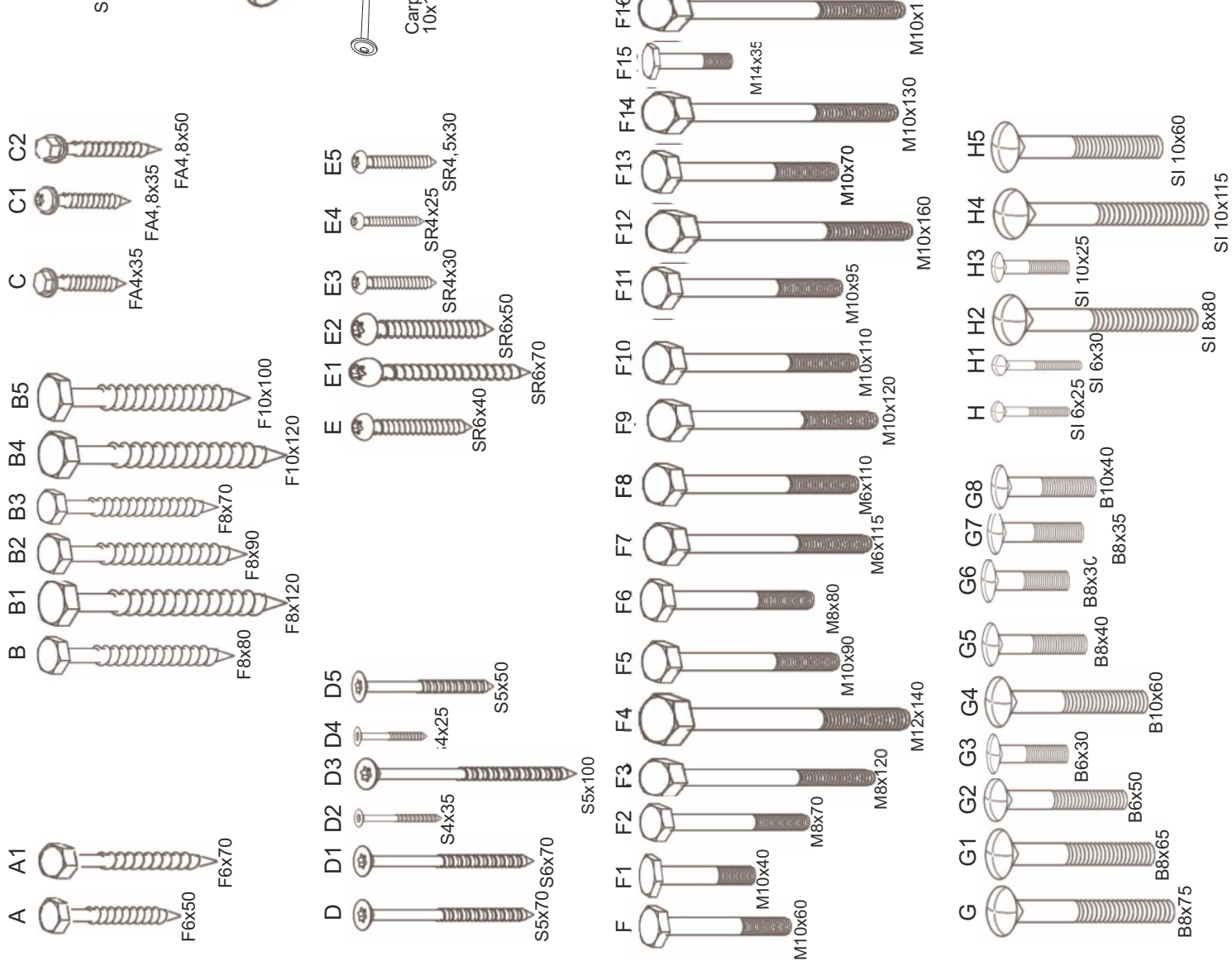
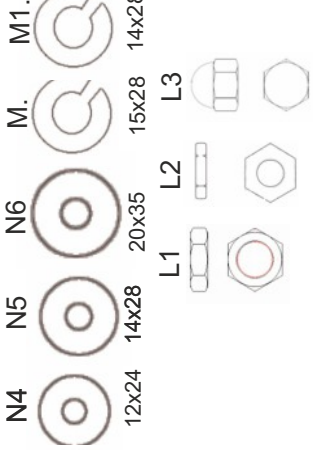
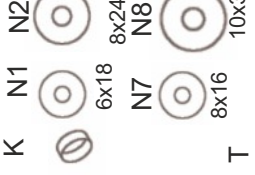
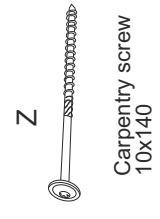
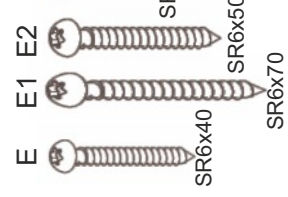
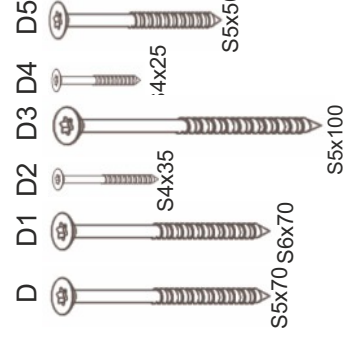
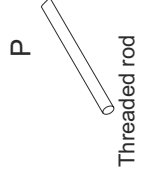
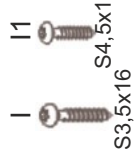
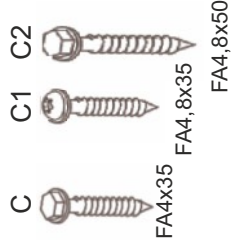
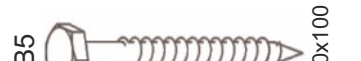
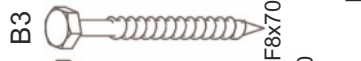
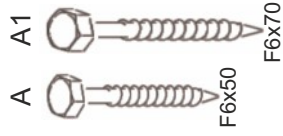

Pre drill before screw.
 Hole in wood for screw: one size smaller than screw.
 Hole in wood for bolt: one size bigger than bolt.
 Hole in plastic: the same size as screw.

Saw if necessary.  Product Plate.

Impregnate surface.  Ground level plate.

Concreted.

Grind surface before install.

Hit with a hammer. 

Cut if necessary. 

Add glue. 